



Intertek

AIRREX[®]

HEAT PUMP

USER'S MANUAL

AHSC-14P /18P



- ▶ Thank you for purchasing the unit.
Before operation, please read this user's manual carefully.

TABLE OF CONTENTS



| | |
|--------------------------------|-------|
| SAFETY INSTRUCTIONS | 3 ~ 4 |
| GENERAL ADVICE BEFORE USE | 4 |
| EXTERIOR DESCRIPTION | 5 ~ 6 |
| SPECIFICATIONS | 7 |
| CONTROL PANEL FUNCTIONS | 8 ~ 9 |
| MODE CHANGING METHOD | 10 |
| HOW TO SET THE 'OFF' TIMER | 11 |
| TEMPERATURE CONTROL OPERATION | 12 |
| SELECTION | 13 |
| 'ERROR' and WARNING INDICATORS | 14 |
| FIRE ALARM | 15 |
| ERROR SIGNAL CONNECTION | 16 |
| ECONOMY MODE | 17 |
| TROUBLE SHOOTING | 18 |
| CLEANING AND MAINTENANCE | 19 |
| WARRANTY | 20 |









The following instructions are to ensure user's safety and to prevent any physical injury or material damage. Please read carefully and follow all instructions. There are two sections to these instructions: WARNING and CAUTION.

-
- ▶ It is essential that you read 'SAFETY INSTRUCTIONS' carefully before use and follow them at all times.
 - ▶ Keep this manual on hand for reference.
 - ▶ This unit is specified for use on the rated voltage power supply.
 - ▶ The warranty form is on the last page. Please complete it now and keep it in a safe place.
 - ▶ We have a policy of continual improving on our products. The contents (features and specifications) in this manual are therefore subject to change without notice.

SAFETY INSTRUCTIONS

- **WARNING** • Keep this manual in a visible location near the unit for easy reference.

The following symbols are for your guidance :  You must NOT.  You MUST.

-  Use a circuit breaker that fits the capacity. (It may cause fire and electric shock)
-  Before cleaning, disconnect the unit. (Otherwise risk of electric shock)
-  Do not use a damaged power cable. (Short, fire or shock hazard)
-  Do not use an extension lead unless of the approved type. (Risk of fire and / or electric shock)
-  Do not place anything on top of the machine. (This could cause electric shock, malfunction or injury)
-  Do not kink or sharply bend the power cable nor put any weight on it. (The insulation may be damaged causing fire or electric shock)
-  Check control panel after turn off circuit breaker first. (Risk of electric shock and / or malfunction)
-  Do not use this unit on unstable or inclined surfaces. Always use on solid flat floor. (Risk of falling causing injury, fire or malfunction)

● INSTALLATION

WARNINGS REGARDING PROPER LOCATION FOR INSTALLATION

-  **WARNING** Do not use the unit in explosive environments or in areas where flammable gas leakage may occur.
- Do not use the unit in areas where it will be exposed to rain or water.
- Do not use the unit in a corrosive atmosphere.
- Do not install the unit on uneven or sloping surface. The unit may roll or topple over even if the casters are set to the locked position.

MOVING THE UNIT

Unlock the casters and push the unit to a flat surface and set the caster brakes to the locked position.

PLUGGING IN THE UNIT

Check the prongs and surface of the power cord plug for dust/dirt. If dust and/or dirt are present, wipe off with a clean, dry cloth.

Check the power cord, plug and prongs for damage or overload.





If any damage or overload is found, contact a qualified repair technician or a qualified electrician to perform replacement or repair of the power cord, plug or prongs.

-  **WARNING** If the power cord or plug is damaged, repair should only be performed by qualified electrical personnel.

-  **WARNING** Do not connect/disconnect the power cord or attempt to operate buttons with wet hands. This could result in electrical shock.

SAFETY INSTRUCTIONS

● CAUTION

-  Do not place this unit on uneven, unstable or inclined surface.
(This could cause malfunction)
-  When storing this unit, keep it in a dry, cool place.
(To prevent corrosion and malfunction)
-  If not being used for some time or if lightening is present, always disconnect power.
(To prevent risk of electric shock, short circuit or fire)
-  Do not spray water onto this unit nor use solvents such as benzene, thinner or alcohol for cleaning.
(There is a risk of electric shock and / or short circuit)
-  Designed for indoor use.

GENERAL ADVICE BEFORE USE

- Ensure the safety of the location in which the unit is to be used.
- Ensure the floor or ground is smooth and flat.
- Ensure at least 20 inch space side of the unit.
- When in position, LOCK the casters to prevent rolling.
- Never use the unit at more than 2° incline.
- If you use condensate pump, connect it to the housing in the condensate tank.
- You have to connect standard power cable.
If the power cable is damaged, it must be replaced by its service agent or qualified person in order to avoid a hazard.

● FOR MAXIMUM EFFICIENCY

- In airtight areas use vertical exhaust into ceiling.
- If possible, send exhaust out through a window or door to outside.
- Ensure rated electricity supply.



Waste electrical and electronic products must be disposed separately from normal household waste. When you dispose of such products, please recycle where facilities exist. Follow the guidance of your local authority and/or ask the shop where you purchased the product.

EXTERIOR DESCRIPTION

● FRONT VIEW

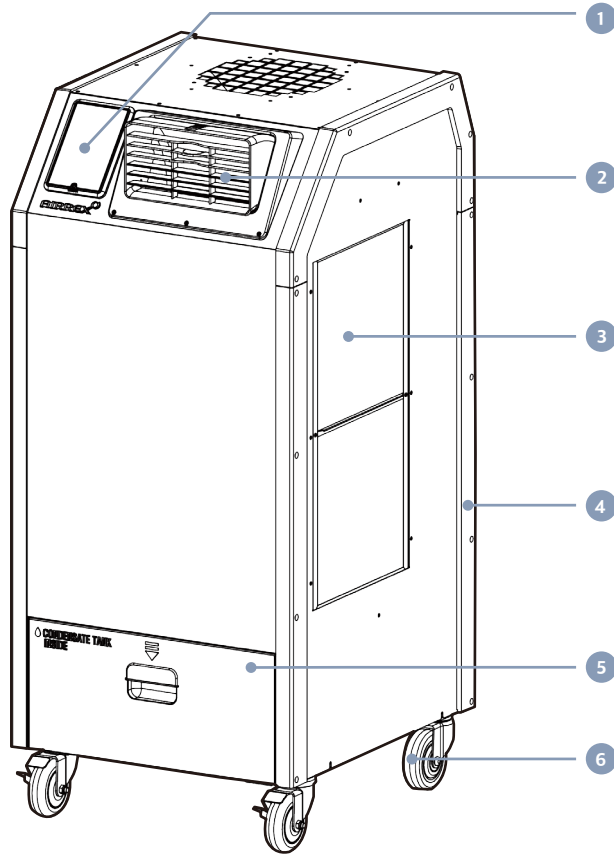

- | | |
|--|--|
| 1 Digital Controller | 2 Louver Outlet (Cool air in A/C, Warm air in Heater) |
| 3 Evaporator Filter (Ambient air inlet) | 4 Protection Bumper |
| 5 Condensate Tank Door (Condensate Tank Inside) | 6 Casters (Front Lockable) |

EXTERIOR DESCRIPTION

● BACK & SIDE VIEW

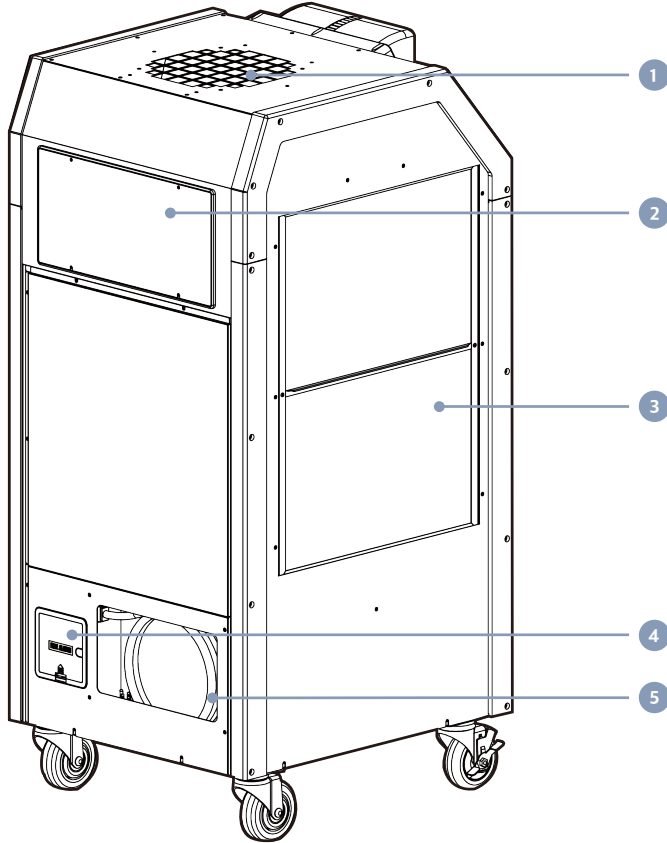

- 1 Hot Air Outlet
- 2 Electrical Access Panel
- 3 Condenser Filter
- 4 Fire Alarm Connection Port
- 5 Power Cord







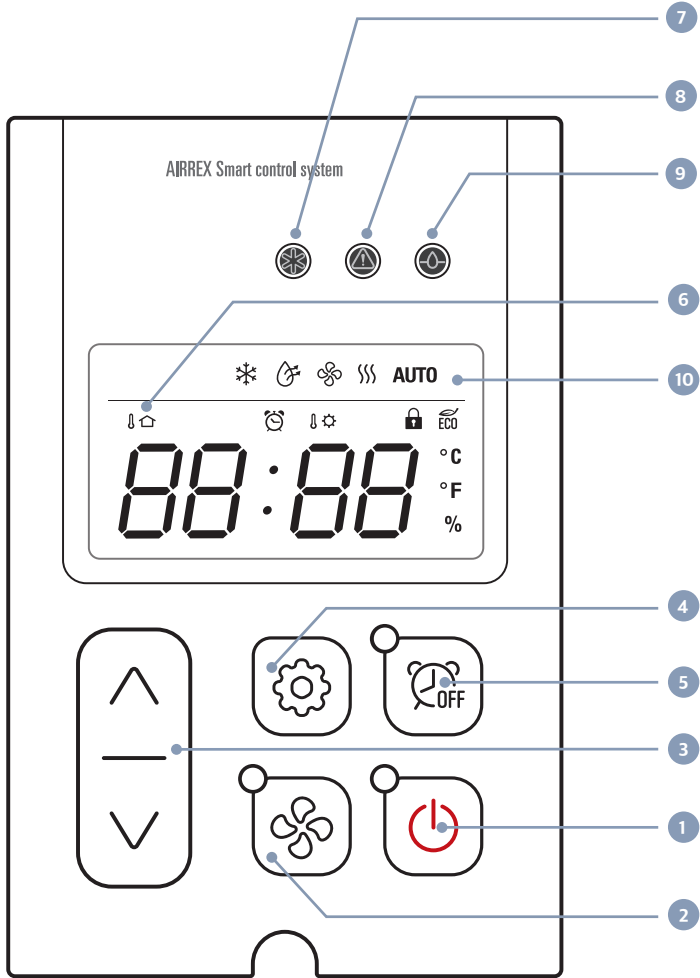



SPECIFICATIONS

| MODEL | | | AHSC-14P | AHSC-18P |
|------------------------|------------------|--------------|------------------------|-------------------|
| Capacity | Cooling | Btu/h (W) | 13,600 (4,000) | 16,800 (4,900) |
| | Heating | | 13,000 (3,800) | 16,800 (4,900) |
| Power Supply | | - | 115 V~, 60 Hz, 1 Ph | |
| Power Consumption | Cooling | kW | 1.3 | 1.72 |
| | Heating | | 1.16 | 1.61 |
| Current Consumption | Cooling | A | 11.7 | 15.8 |
| | Heating | | 10.6 | 14.6 |
| Dehumi- dification | Max. | gal/day | 27 | 30 |
| | Nom. | gal/day | 15 | 18 |
| Refrigerant (R-410A) | | lbs | 2.65 | 2.87 |
| Dimensions (W x D x H) | | inch | 22 x 25 x 49 | |
| Weight | | lbs | 176 | 178 |
| Operating Conditions | Cooling | | 61 ~ 115°F (16 ~ 46°C) | |
| | Heating | | 46 ~ 81°F (8 ~ 27°C) | |
| | Dehumidification | | 55 ~ 115°F (13 ~ 46°C) | |
| Power Cord | | | LCDI 5-15 | LCDI 5-20 |

CONTROL PANEL FUNCTIONS



CONTROL PANEL FUNCTIONS

| NAME | DESCRIPTION |
|---------------------|--|
| 1 Power |  Use to power on / off. |
| 2 Fan Speed |  Controls fan low / high speed. |
| 3 ∨ ^ Button |  Raises or lowers the setting temperature or sleep (off) time. |
| 4 Mode |  Use to select Cooling / Dehumidification / Fan / Heating / Auto mode. |
| 5 Off Timer |  You can set the time to stop the unit. You can set 0~24 hours. Time intervals are 30 mins. up to 10 hours and then 1 hour between 10 and 24 hours. |
| 6 Room |  If the LCD is on, the displayed temperature is for room temp. |
| 7 Comp |  When the compressor is operating, the LED is on. |
| 8 Error |  Error signal. |
| 9 Check |  If water is full or Align drain tank needs to be checked, the LED is on. |
| 10 Display |  Display room temperature, and also the setting temperature and sleep time if they had been set. |

MODE CHANGING METHOD



● COOLING MODE

If you press the 'Mode' button, 'Cooling symbol' is displayed.



● DEHUMIDIFICATION MODE

If you press the 'Mode' button when the 'cooling' is operating, 'dehumidification symbol' is displayed.



● FAN MODE

If you press the 'Mode' button when the 'Dehumidification' is operating, 'Fan symbol' is displayed.



● HEATING MODE

If you press the 'Mode' button when the 'fan' is operating, 'Heating symbol' is displayed.



● AUTO MODE

If you press the 'Mode' button when the 'heat' is operating, 'AUTO' is displayed.

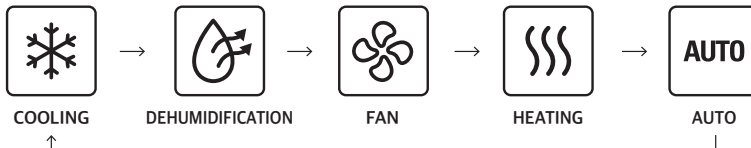

HOW TO SET THE 'OFF' TIMER

This function enables you to set the length of time you want the unit to operate.

STEP 1

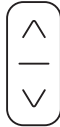
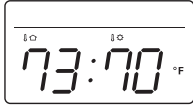

1. When unit is operating, press the 'Off Timer' button and set the length of time you want by pressing \wedge or \vee . Each time you press the button you will increase the 'time to off' period by 30 mins. up to 10 hours, and 1 hour up to 24 hours. The display will show 0.5 for 30 min and 1 for an hour. One and a half hours will show 1.5.

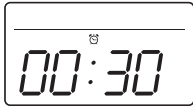

STEP 2

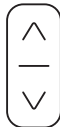

2. When you have finished setting the time period, the 'Off Timer' lamp will be on which indicates the unit is in sleep (Off Timer) mode.

OFF TIMER LAMP IS ON

STEP 3

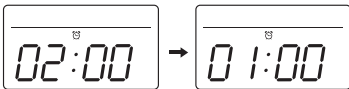

AFTER 1hr

3. If you press the 'Off Timer' button during its operation, the remaining time will be shown.

CANCEL

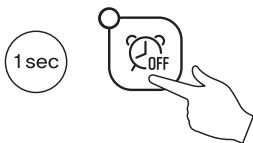

4. To cancel 'Off Timer', press and hold 'Off Timer' button for 1 second. It will then switch the timer off automatically.

TEMPERATURE CONTROL OPERATION

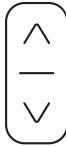
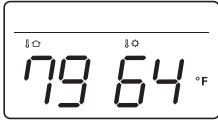

- When you turn ON, the setting temperature is displayed.
- You can change setting temperature.

● Display Room Temperature Range & Setting Range.

COOLING MODE

| Mode | Display range | Setting range |
|------|---------------|---------------|
| Room | 32°F ~ 99°F | 61°F ~ 86°F |
| Spot | | 34°F ~ 86°F |

Cooling operates when room temperature is higher than set temperature.

Cooling stops when room temperature is lower than set temperature.

HEATING MODE

| Mode | Display range | Setting range |
|------|---------------|---------------|
| Room | 32°F ~ 99°F | 68°F ~ 99°F |

Heating operates when room temperature is lower than set temperature.

Heating stops when room temperature is higher than set temperature.

AUTO MODE

| Mode | Display range | Setting range |
|------|---------------|---------------|
| Room | 32°F ~ 99°F | 70°F ~ 77°F |

When room temperature is higher than set temperature, cooling operates and when room temperature is lower than set temperature, heating operates automatically.

SELECTION

● SPOT or ROOM MODE

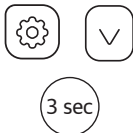
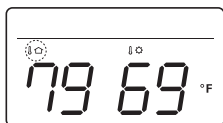

To change the temperature of the entire room, select 'Room mode'. For targeted cooling of machinery servers or people etc select 'Spot mode'. Applicable only when cooling mode.

- If you want to see room temperature, when unit is operated, push 'mode' and 'v' button simultaneously for 3 seconds.
- Light be on the 'Room LED' when room mode set.

● LOCK or UNLOCK

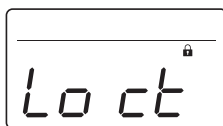

- If you press 'v' for 5 seconds when the unit is turned off, you can control 'LOCK, UNLOCK' mode.

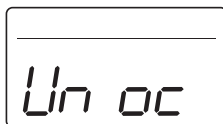





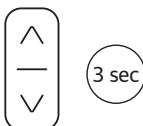
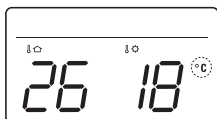
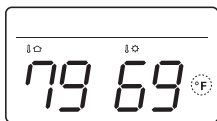







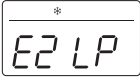

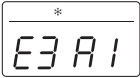

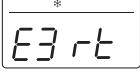

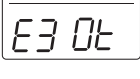

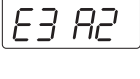
- You can set 'UNLOCK' or 'LOCK' after pressing '^' button.

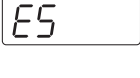
● TEMPERATURE UNIT

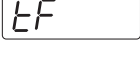

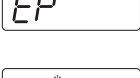
- If you want to change temperature unit °F ↔ °C, when the unit is stopped, push 'v' and '^' button simultaneously for 3 seconds.

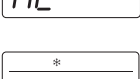
'ERROR' and WARNING INDICATORS

| Error Code | Problem | Cause | Corrective Action |
|---|---|---|--|
|  |  High pressure | Blocked COND filter. Blocked / kinked exhaust duct. Ambient temperature is too high. | Clean the COND filter. Ensure exhaust duct is not blocked / kinked. Do not use the air conditioner if ambient temperature is higher than 113°F. |
|  |  Low pressure | Verify Electrical. Refrigerant may be low or empty. | Verify Power (Voltage / Amps). Check refrigerant level and refrigerant leakage. Clean Filter and Coil. Check Evaporator Filter. Check Evaporator Coil. |
|  |  AF1 sensor | If the AF1 sensor is short circuited or cut 'E3 A1' displayed and the 'Error' LED will be on. | Exchange AF1 sensor. |
|  |  RT sensor | If the RT sensor is short circuited or cut 'E3 rt' displayed and the 'Error' LED will be on. | Exchange RT sensor in digital controller. |
|  |  OT sensor | If the OT sensor is short circuited or cut 'E3 Ot' displayed and the 'Error' LED will be on. | Exchange OT sensor. |
|  |  AF2 sensor | If the AF2 sensor is short circuited or cut 'E3 A2' displayed and the 'Error' LED will be on. | Exchange AF2 sensor. |
|  |  BLDC Motor | If BLDC motor is not operated, 'E5' displayed and the 'Error' LED will be on | Check or change BLDC motor |
|  |  Water full | Water tank is full. | Empty the water tank. |
|  |  Align water tank | Water tank is not positioned correctly. | |
|  |  Fire alarm signal | Fire alarm signal is detected from Fire alarm system. | Reset unit by pushing and holding the "OFF TIMER" button for 5 seconds. |
|  | Anti-Freezing alarm | Evaporator is below 25°F (-2°C) due to being used in a low ambient temperature area. | Do not use the unit in an ambient temperature less than 61°F (16°C). Check refrigerant level. |

FIRE ALARM

● Input terminal FA1 and FA2

When the signal from the fire alarm system is detected, the unit turns off and does not operate until the unit has been RESET.

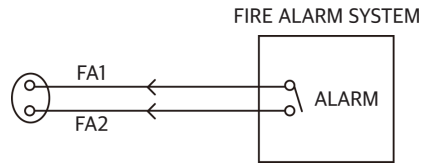
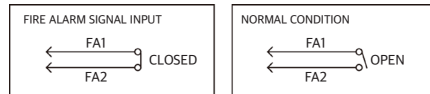
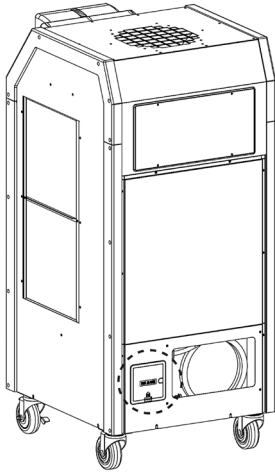

● Connecting the fire alarm wire from fire alarm system

1. Remove the 'Cap' on the 'Fire Alarm Cover'.
2. Use recommended fire alarm wire size from 16 AWG to 26 AWG for a solid wire, or 16 AWG to 22 AWG for a stranded wire with ring terminal for #5 stud size.
3. Connect fire alarm to terminal FA1 and FA2.

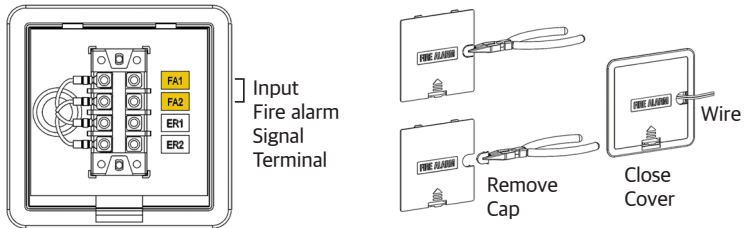

ERROR SIGNAL CONNECTION

● Output terminal ER1 and ER2

The unit will output an Error signal (normal open dry contact) when an "Error" has occurred, to show what the failure is on the unit.

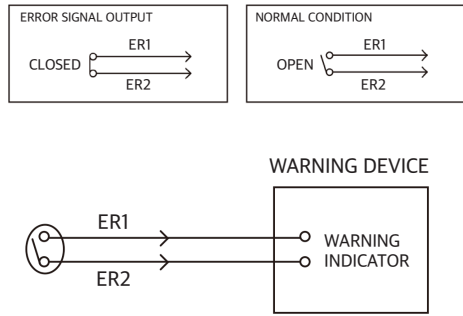
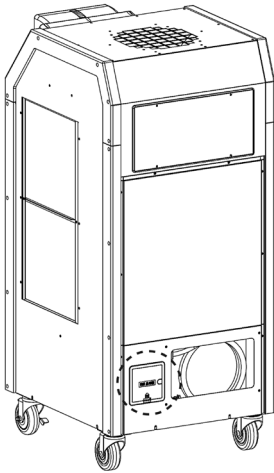





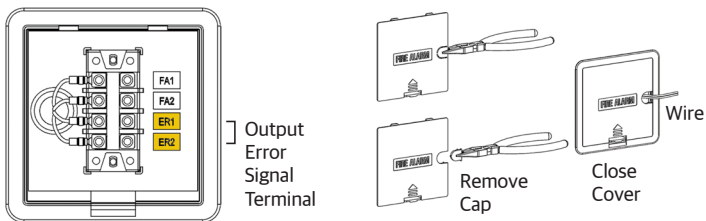

● Connecting Error Signal with Warning Device

1. Remove the 'Cap' on the 'Fire Alarm Cover'.
2. Use recommended error signal wire size from 16 AWG to 26 AWG for a solid wire, or 16 AWG to 22 AWG for a stranded wire with ring terminal for #5 stud size.
3. Connect the end of the error signal wire to ER1 and ER2, and the other end to the compatible with various warning devices such as alarm speaker, light indicators, and etc.



ECONOMY MODE

| Model | Evap. Fan | | Cond. Fan | | Economy mode (Push the button for 3 sec.) | Etc. |
|------------------------|--------------------|--------|-------------------|--------|---|-------------------|
| | Economy | Normal | Economy | Normal | | |
| HSC-12L | Stop after 30 sec. | Run | - | - |  | Fan integral type |
| HSC-14P/18P/24P | Stop after 30 sec. | Run | - | - |  | Fan integral type |
| HWC-19 | Stop after 30 sec. | Run | Stop | Run |  (High) | |
| HSC-36P/60P/70P | Stop after 1 min. | Run | Stop after 1 min. | Run |  | |
| AHSC-14P/18P | Stop after 30 sec. | Run | - | - |  | Fan integral type |
| AHSC-42/60 | Stop after 30 sec. | Run | Stop | Run |  | |
| AHSC-140P | Stop after 1 min. | Run | Stop after 1 min. | Run |  | |

TROUBLE SHOOTING

| TROUBLE | CHECK | REMEDY |
|--------------|----------------------------------|---|
| NOT WORKING | Power cable correctly connected. | Connect cable correctly. |
| | Power button "OFF". | Press POWER button to "ON". |
| | Fuse (supply) blown. | Exchange fuse in board. |
| | Breaker on switch board tripped. | Check load capacity and reset. |
| | Ambient temperature too high. | Check operating temperature range. |
| POOR COOLING | Filter blocked with dust. | Clean Filter. |
| | Dust in heat exchanger. | Clean heat exchanger. |
| | Obstacle against inlet side. | Remove and allow 20" (50 cm) clearance. |

CLEANING AND MAINTENANCE

● CLEANING THE AIR FILTERS

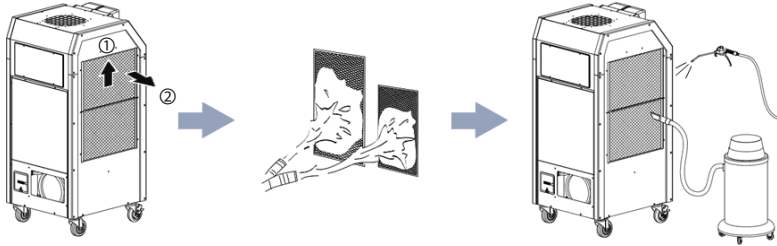

1. To remove filters, slide up a little ① and pull towards you ②.
2. Clean the filters with water or compressed air.
3. Clean evaporator and condenser units with a vacuum cleaner or compressed air.

● MAINTENANCE

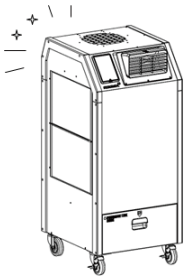

1. After cleaning, completely dry the inside of the unit by operating on 'Fan Mode'.

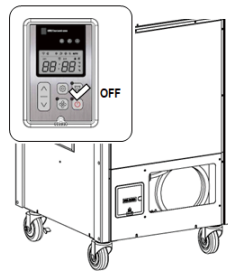

2. Turn "OFF" at control panel, remove plug from socket. Coil and store cable neatly.



3. Keep machine suitably covered to prevent damage by damp, humidity and dust.

WARRANTY

(Applicable to first retail purchaser only)

AIRREX unit gives the more reliable performance, comfort and durability the more they are used. They are built under a strict quality assurance regime which includes inspection both during and after production and exhaustive reliability testing.

In the unlikely event you have any problems, please contact your dealer or distributor. If the problem is as a result of a production fault or failure, repairs will be undertaken free of charge during the period of warranty subject to the following warranty conditions:

1. If the problem has been caused by customer error or misuse, abuse or damage, then all repairs will be charged for.
2. This warranty applies to your country.
3. Proof and date of purchase must be supplied.
4. Please complete the details below and keep this warranty in a safe place.
5. All transportation charges back to the dealer are at customer's cost. Keep all original packaging to facilitate return. Return to customer will be at dealer's cost (if genuine warranty claim).

| | | | |
|-------------------------|------------------|---------------------------|--|
| DESCRIPTION | AIRREX HEAT PUMP | | |
| MODEL | AHSC-14P / 18P | | |
| DATE OF PURCHASE | | PRODUCT SERIAL NO. | |
| WARRANTY PERIOD | () Months | | |
| DISTRIBUTOR | Name of Company | | |
| | Telephone No. | | |
| CUSTOMER DETAILS | Name : | | |
| | Address : | | |
| | Telephone : | | |

Distributed by :
Airrex USA
2031 Exchange Parkway, Waco, TX 76712

TEL : 888-535-8841
E-mail : sales@airrexusa.com
Website : www.airrexusa.com